

Temperature Compensated Crystal Oscillators [TCXO " M " and VCTCXO " VM "]

Clipped Sine Wave ; Waveform code " S " [SMD Type]

Features

- Frequency stability as tight as ± 0.5 ppm over -30°C to 85°C
- Frequency stability as tight as ± 1.0 ppm over -40°C to 85°C

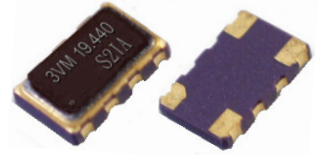

General Specifications [$T_A = +25^{\circ}\text{C}$, $V_{DD} =$ at specified voltage , Load : 10K ohms//10 pF]

Output Waveform		Clipped Sine wave . Waveform code is " S "						
Suggested package (SMD type)		M21S , VM21S	M22S , VM22S	M32S , VM32S				
Pads		6	4	4				
Package size		2.0 x 1.6 x 0.7 mm	2.5 x 2.0 x 0.8 mm	3.2 x 2.5 x 1.2 mm				
Supply voltage (V_{DD}) [unit : V]		1.8 , 2.5 , 2.8 , 3.0 , 3.3	1.8 , 2.5 , 2.8 , 3.0 , 3.3	1.8 , 2.5 , 3.0 , 3.3				
Frequency Range		10.0 ~ 52.0 MHz	10.0 ~ 52.0 MHz	8.192 ~ 52.0 MHz				
Suggested package (SMD type)		M53S , VM53S	M57S , VM57S	M572S , VM572S				
Pads		4	4	4				
Package size		5.0 x 3.2 x 1.3 mm	7.0 x 5.0 x 2.0 mm	7.0 x 5.0 x 2.3 mm				
Supply voltage (V_{DD}) [unit : V]		1.8 , 2.5 , 2.8 , 3.0 , 3.3	2.5 , 3.0 , 3.3	1.8 , 2.5 , 2.8 , 3.0 , 3.3				
Frequency Range		6.4 ~ 52.0 MHz	6.4 ~ 52.0 MHz	6.4 ~ 52.0 MHz				
Standard Frequency (Partial list) [MHz]		10.000	12.800	13.000	14.400	14.7456	15.360	16.367667
		16.384	19.200	19.440	20.000	25.000	26.000	27.000
Initial Calibration Tolerance		$< \pm 1$ ppm. at $+25^{\circ}\text{C} \pm 2^{\circ}\text{C}$						
Frequency Stability (ppm)		± 0.5 ppm	± 1.0 ppm	± 1.5 ppm	± 2.0 ppm	± 2.5 ppm	± 3.0 ppm	O : available Δ : contact us X : not available
Frequency Stability vs Temperature (examples)	0°C to 50°C	O	O	O	O	O	O	
	-10°C to 60°C	Δ	O	O	O	O	O	
	-20°C to 70°C	Δ	O	O	O	O	O	
	-30°C to 75°C	Δ	O	O	O	O	O	
	-30°C to 85°C	Δ	O	O	O	O	O	
	-40°C to 85°C	Δ	Δ	O	O	O	O	
Frequency Stability	vs Aging at $T_a = +25^{\circ}\text{C}$	± 1.0 ppm / year (max.)						
	vs Voltage Change	± 0.2 ppm (max.) , for a $\pm 5\%$ input voltage change .						
	vs Load Change	± 0.2 ppm (max.) , for a $\pm 10\%$ load condition change .						
	vs Reflow (SMD type)	± 1.0 ppm (max.) , 1 reflow and measured 24 hours afterwards .						
Output Voltage Level (peak to peak)		0.8 V p-p (min.)						
Current Consumption. (max.)		10.0 ~ 15 MHz: 1.5 mA ; 15.1 ~ 26.0 MHz : 2.0 mA ; 26.1 ~ 52.0 MHz : 3.5 mA						
Electrical Frequency Tuning (EFC) by external	Control Voltage Center	1.8 V		2.5 V		3.0 V / 3.3V		
		0.9 V \pm 0.6 V		1.4 V \pm 1.0 V		1.5 V \pm 1.0 V		
	Frequency Deviation Range	± 5.0 ppm (min.)						
	Slope Polarity (Transfer Function)	Positive slope. Positive voltage for positive frequency shift.						
Control Voltage		Input Impedance : 1.0M Ω (min.)		Modulation Bandwidth : 3 KHz (min.)		Linearity : $\pm 10\%$ (max.)		
Start-Up Time	2.0 msec. (typ.) , 5.0 msec. (max.) (reach 90% amplitude and at $+25^{\circ}\text{C} \pm 2^{\circ}\text{C}$)							
Output Load	10 K Ω // 10 pF $\pm 10\%$							
Output Format	DC block , AC coupled. EX : (V) M53 and (V) M32 model.							
Phase Noise [dBc / Hz ; (typ.)]	Offset	10 Hz	100 Hz	1 KHz	10 KHz	10 KHz		
	13.0 MHz	-80	-115	-135	-148	-148		
Storage Temperature	-40°C to $+85^{\circ}\text{C}$ or -55°C to $+125^{\circ}\text{C}$ (package dependent)							

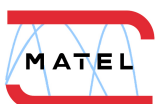

MATEL Centre d'affaires Laroiseau 1 rue Anita Conti 56000 VANNES

+33 (0)2 97 60 98 34 www.matel-piezo.fr

Temperature Compensated Crystal Oscillators [TCXO " M " and VCTCXO " VM "]

Clipped Sine wave output code " S " [SMD Type]

Outline Dimensions (Unit : mm) , Suggested pad Layout for SMDs

[M21S __] ; [VM21S __]

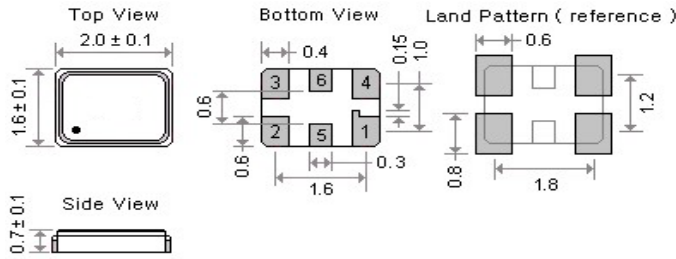

Pad Connections :

Pad 1 : Control voltage for VCTCXO ; Ground for TCXO .
Pad 2 : Ground ; Pad 3 : Output , Pad 4 : Supply Voltage
Pad 5 : No connect ; Pad 6 : No connect

[M22S __] ; [VM22S __]

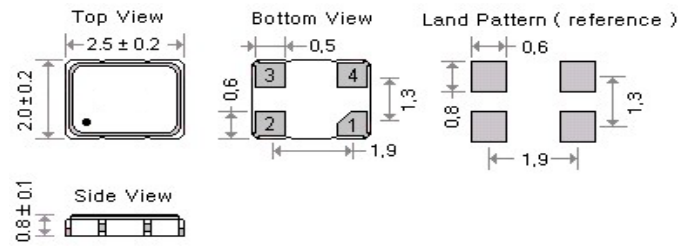

Pad Connections :

Pad 1 : Control voltage for VCTCXO ; Ground for TCXO .
Pad 2 : Ground ; Pad 3 : Output , Pad 4 : Supply Voltage

[M32S __] ; [VM32S __]

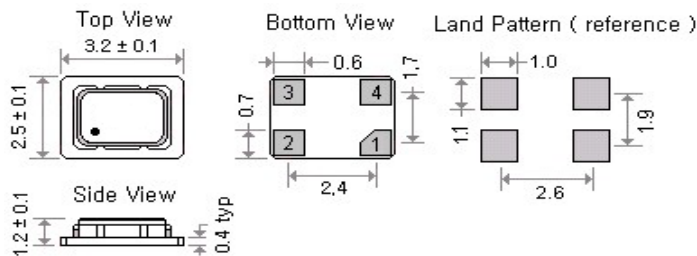

Pad Connections :

Pad 1 : Control voltage for VCTCXO ; Ground for TCXO .
Pad 2 : Ground ; Pad 3 : Output , Pad 4 : Supply Voltage

[M53S __] ; [VM53S __]

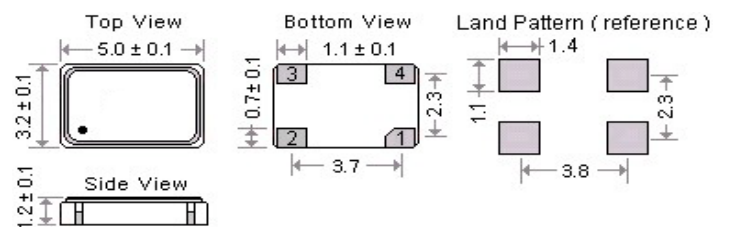

Pad Connections :

Pad 1 : Control voltage for VCTCXO ; Ground for TCXO .
Pad 2 : Ground ; Pad 3 : Output , Pad 4 : Supply Voltage

[(V) M57S __] ; [(V) M572S __]

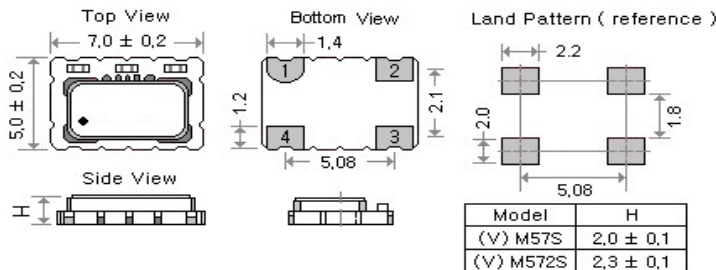

Pad Connections :

Pad 1 : Control voltage for VCTCXO ; Ground for TCXO .
Pad 2 : Ground ; Pad 3 : Output , Pad 4 : Supply Voltage

[M47S __] ; [VM47S __]

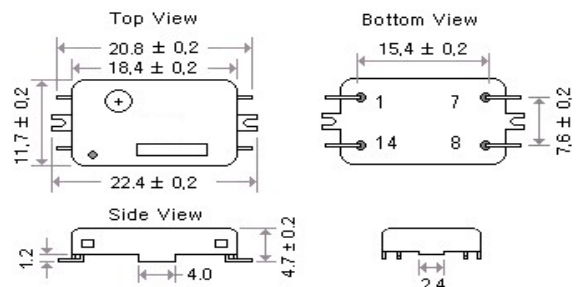

Pad Connections :

Pad 1 : Control voltage for VCTCXO. Make no connection if TCXO.
Pad 7 : Ground ; Pad 8 : Output , Pad 14 : Supply Voltage

[M43S __] ; [VM43S __]

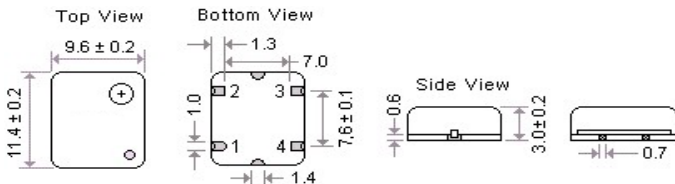

Pad Connections :

Pad 1 : Control voltage for VCTCXO ; Ground for TCXO .
Pad 2 : Ground ; Pad 3 : Output , Pad 4 : Supply Voltage

[M63S __] ; [VM63S __]

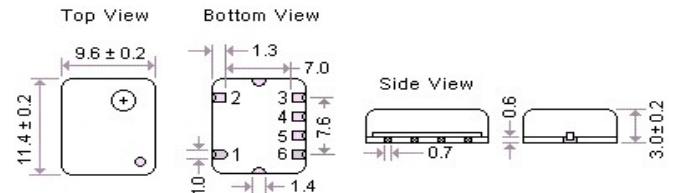

Pad Connections :

Pad 1, 2, 4 : Ground , Pad 3 : Output , Pad 6 : Supply Voltage
Pad 5 : Control voltage for VCTCXO. Make no connection if TCXO.



MATEL Centre d'affaires Laroiseau 1 rue Anita Conti 56000 VANNES

+33 (0)2 97 60 98 34 www.matel-piezo.fr

Temperature Compensated Crystal Oscillators [TCXO " M " and VCTCXO " VM "]

Clipped Sine wave output code " S "

Part Number Format and Example

	[1]	[2]	[3]	-	[4]	-	[5]	/	[6]
	Holder Type	Output Wave	Supply Voltage		Center Frequency		Frequency Stability		Operating Temp. Range
Examples	(1) V M 39	S	3	-	10.000	-	1.5	/	-20+70
	(2) M 32	S	18	-	20.000	-	2.5	/	-30+75

Ex (1) : VM39S3 - 10.000 - 1.5 / -20+70 [VCTCXO , VM39 type , Clipped Sine Wave, 3.0V , 10.000MHz , ±1.5ppm from -20°C to 70°C]

Ex (2) : M32S18 - 20.000 - 2.5 / -30+75 [TCXO , M32 type , Clipped Sine Wave , 1.8V , 20.000MHz , ±2.5ppm from -30°C to 75°C]

[1]	Holder Type " M " stands for TCXO , " VM " stands for VCTCXO
[2]	" S " stands for Clipped Sine Wave
[3]	Supply voltage , " 18 " stands for +1.8V ; " 25 " stands for +2.5V ; " 28 " stands for +2.8V ; " 3 " stands for +3.0V ; " 33 " stands for +3.3V
[4]	Center Frequency in MHz
[5]	Frequency stability in ± ppm ; ex 1 : ± 2.5ppm --- 2.5 , ex 2 : ± 1.0ppm --- 1.0
[6]	Operating temperature range in °C ex 1 : -10 °C to 60°C ----- -10+60 ; ex 2 : -20 °C to 70°C ----- -20+70 ; ex 3 : -30 °C to 85°C ----- -30+85

Clipped Sine Wave Typical Phase Noise (M22S33-52.000)

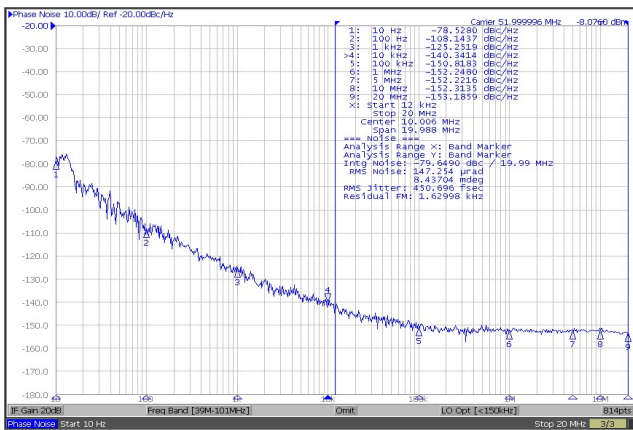

Clipped Sine Wave , " S " series

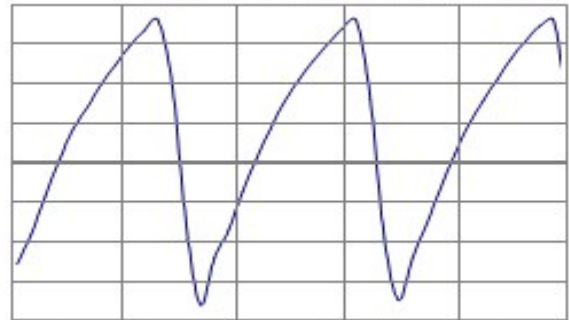

(VC)TCXO with clipped sine wave Test Circuits : Ex. VM14S3

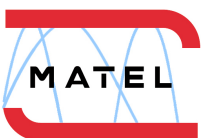
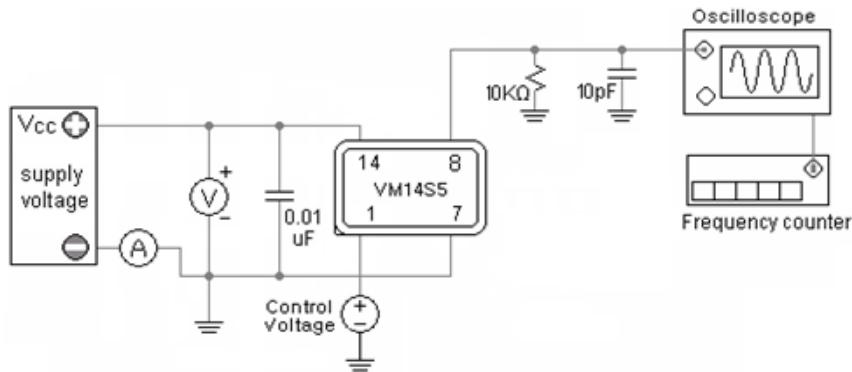

MATEL Centre d'affaires Laroiseau 1 rue Anita Conti 56000 VANNES
+33 (0)2 97 60 98 34 www.matel-piezo.fr

Emboss Taping and Reel Specifications

[VCXO]

[(VC)TCXO]

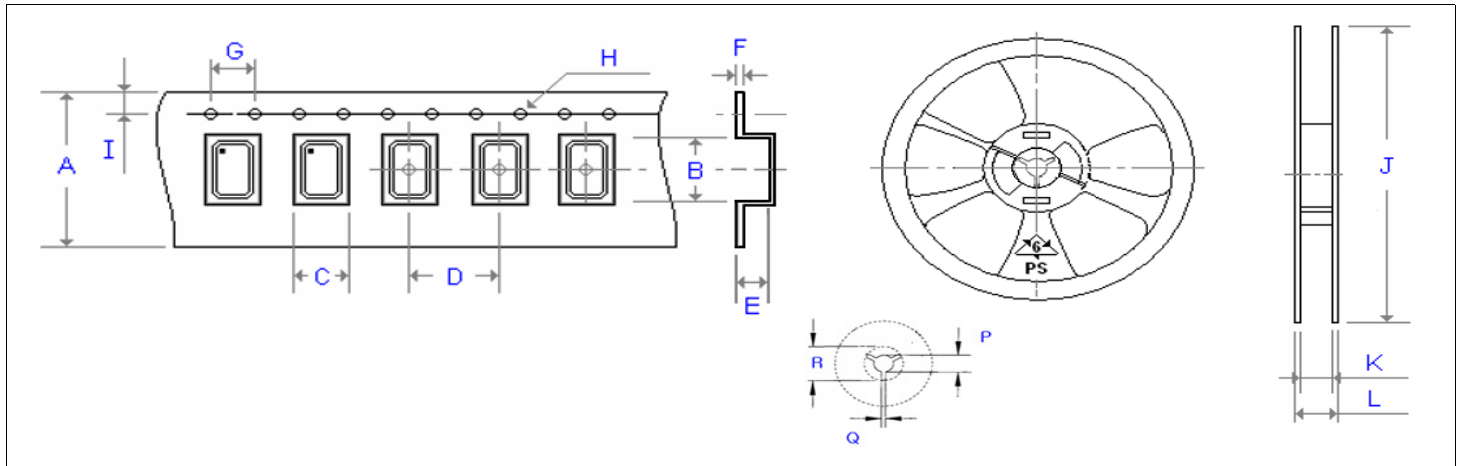

Carrier Type Dimensions (unit : mm) ±0.3mm

	A	B	C	D	E	F	G	H	I	pcs / reel
G_226	8.00	2.80	2.25	4.00	1.10	0.30	4.00	∅ 1.50	1.75	3000
G_326	8.00	3.40	2.70	4.00	1.40	0.25	4.00	∅ 1.50	1.75	3000
G_534	12.00	5.30	3.60	8.00	1.40	0.30	4.00	∅ 1.50	1.75	1000
G_576	16.00	7.30	5.30	8.00	1.90	0.32	4.00	∅ 1.50	1.75	1000
G_43	24.00	11.80	10.00	16.00	5.00	0.30	4.00	∅ 1.50	1.75	500
G_63	24.00	11.80	10.00	16.00	5.00	0.30	4.00	∅ 1.50	1.75	500
G_JF538	12.00	5.30	3.60	8.00	1.40	0.30	4.00	∅ 1.50	1.75	1000
G_JF578	16.00	7.30	5.30	8.00	1.90	0.32	4.00	∅ 1.50	1.75	1000
(V)M21	8.00	2.30	1.90	4.00	0.90	0.25	4.00	∅ 1.50	1.75	3000
ME21	8.00	2.30	1.50	4.00	1.35	0.25	4.00	∅ 1.50	1.75	3000
(V)M22	8.00	2.80	2.25	4.00	1.10	0.30	4.00	∅ 1.50	1.75	3000
(V)M_32	8.00	3.71	2.80	4.00	1.75	0.25	4.00	∅ 1.50	1.75	3000
(V)MQ_326	12.00	3.60	2.90	4.00	1.70	0.30	4.00	∅ 1.50	1.75	3000
(V)M_53	12.00	5.30	3.60	8.00	1.40	0.30	4.00	∅ 1.50	1.75	1000
(V)M_57(2)	16.00	7.40	5.50	8.00	2.80	0.35	4.00	∅ 1.50	1.75	500
(V)M_43 (63)	24.00	11.80	10.00	16.00	5.00	0.30	4.00	∅ 1.50	1.75	500

Reel Dimensions (unit : mm) ±2mm

	J	K	L	P	Q	R	pcs / reel
G_226	180.00	8.40	11.40	13.00	2.50	20.20	3000
G_326	180.00	9.00	12.00	13.00	2.50	20.20	3000
G_534	180.00	13.00	16.00	13.00	2.50	20.20	1000
G_576	180.00	17.20	19.30	13.00	2.50	20.20	1000
G_43	330.00	24.50	29.10	13.00	2.50	20.20	500
G_63	330.00	24.50	29.10	13.00	2.50	20.20	500
G_JF538	180.00	13.00	16.00	13.00	2.50	20.20	1000
G_JF578	180.00	17.20	19.30	13.00	2.50	20.20	1000
(V)M21	180.00	8.40	11.40	13.00	2.50	20.20	3000
ME21	180.00	9.00	12.00	13.00	2.50	20.20	3000
(V)M22	180.00	8.40	11.40	13.00	2.50	20.20	3000
(V)M_32	180.00	9.00	11.40	13.00	2.50	20.20	3000
(V)MQ_326	180.00	13.00	16.00	13.00	2.50	20.20	3000
(V)M_53	180.00	13.00	16.00	13.00	2.50	20.20	1000
(V)M_57(2)	180.00	17.20	19.30	13.00	2.50	20.20	500
(V)M_43 (63)	330.00	24.50	29.10	13.00	2.50	20.20	500

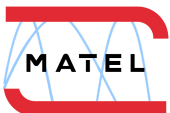

MATEL Centre d'affaires Laroiseau 1 rue Anita Conti 56000 VANNES

+33 (0)2 97 60 98 34 www.matel-piezo.fr